

SPRING/SUMMER 2025

DESIGN & DECOR



Whitfield Floor Plan
NATIONWIDE
SERIES



STANDARD SPECIFICATIONS

Homestead/Mainstreet

STRUCTURAL

- Exterior Walls: 2"x 6" Wall Studs, 16" o.c.
- Ceiling Height: 8'
- Interior Walls: 2"x 4" Wall Studs, 16" o.c.
- Double Top Plates on Interior and Exterior Walls
- Mating Walls: 2"x 3" or 2"x 4" (Per Plans)
- Floor Joist: 2x10 @ 16" o.c.
- Floor Decking: ¾" Tongue-and-Groove OSB
- Exterior Wall Sheathing: 7/16" OSB
- Roof Pitch: 7/12, 9/12 & 12/12 Pitch @ 24" o.c. (Per Plans)
- Roof Sheathing: 7/16" OSB with Ply-Clips
- Overhangs: 12"

EXTERIOR

- Siding: Double 5 Straight/Traditional Lap Vinyl Siding w/White Corners
- White Prefinished Fascia/Drip Edge; White Vinyl Soffit
- Roof Shingles: Architectural Over Synthetic Roof Underlayment
- Ridge Ventilation System
- Titan House Wrap
- Porches: 6" White Vinyl Post Wrap, Rails and Pickets (Per Plans)
- Windows: KINRO Single Hung Vinyl w/Screens, DP50, Low-E, 4/1 Grid Pattern
- 2" Window Blinds: OPTIONAL
- Exterior Window Treatment @ Front Elevation: 3" White Vinyl Trim
All Shutters: OPTIONAL with 3" White Vinyl Trim (Included)
- Front Door: 3 to Choose From (See Décor Selector Guide)
- Rear/Utility Door: ½ Glass 4-Lite S262
- Sidelights: OPTIONAL
- Kwikset Smart Key Knob with Deadbolt

PLUMBING

- Bath Fixtures: White
- Toilets: Elongated, Vitreous China
- Tubs and Showers: Fiberglass
- Glass Bypass Brushed Nickel Shower Door-48"/60" Showers (Per Plans)
- 4x6 or 4x8 Ceramic Shower @ Bath 1 (Per Plans): Includes Fiberglass Pan, Hand-Held Wand, Rainfall Shower Head and LED Light
- Pedestal Tub @ Bath 1 (Per Plans)
- Bath Faucets: Dual Handle Brushed Nickel Finish
- Bath Sink: 21" x 18" Rectangle
- Plumb for Ice Maker (Recessed Box In Wall)
- Plumbing Supply System: PEX
- Drain, Waste & Vent System: PVC
- Water Heater: Electric 50-Gallon High Efficiency
- Kitchen Sink: 8" Deep Stainless Steel, Double Bowl with Gooseneck Brushed Nickel Faucet
- Whole House Shut Off Valve
- One Exterior Hose Bib

INSULATION & HEATING/COOLING

- Floor Insulation: OPTIONAL
- Exterior Walls: R-19 Insulation
- Ceiling: R-38 Insulation (R-30 Between Knee Walls and Under Floor Decking of Capes and Triple Wide Models)
- Return Air Grille with Plenum & Pull Wire for Thermostat
- Floor Registers: OPTIONAL

INTERIOR FINISH

- Walls: 1/2" Drywall Primed, Smooth Finish, Painted Gray
- Ceilings: 1/2" High Strength Drywall, Smooth Finish, Painted White
- Base Molding: 3 ¼" Speed/Finished Coat (Pine)
- Door & Window Casing: 2 ¼" Colonial/Primed & Finished (Pine)
- 4-1/4" Crown Mold T/O (Except Closets) (Pine)
- Stairs: Carpet Grade w/Pine Treads-Sloped Wall w/Cap, Prefinished Handrail, White Skirt Boards-Pickets-Newel Posts (Per Plans)
- Carpet: 25 oz FHA with Deluxe 6# Padding (Shipped Loose) For Bedrooms, Bedroom Closets and Den
- Resolve Vinyl Plank Flooring (LVP): Baths and Utility
- Resolve Vinyl Plank Flooring (LVP): Living Room, Dining Room, Kitchen, Hall and Foyer (Shipped Loose)
- Interior Doors: Two Panel Hardboard
- Lever Brushed Nickel Interior Locksets
- Cabinets: DuraBuilt Hardwood Shaker, 36" Wall with Crown, Soft-Close Doors & Drawers, Brushed Nickel Knobs & Matching Toe Kicks, Lazy Susan, Pot & Pan Drawer
- Countertops: Laminate with Crescent Edge T/O
- Backsplash: Kitchen—Ceramic (See Décor Selector Guide for Standards)
- Backsplash: Baths-4" Matching Laminate (Ceramic Optional)
- Vanity Mirrors: White Framed
- Shower Rods and Bath Accessories by Purchaser
- Closet Shelving: Ventilated Epoxy Coated - Shelving Layout per Plans, Shoe Cubby in BR1 Closet, Storage/Shelving over Washer/Dryer
- Bench/Cubby in Utility Room or Foyer – If shown on Plans

ELECTRICAL

- Main Electric Panel: 200 AMP
- Smoke Detectors: Per Plan
- Interior Lighting: BN Fixtures, Wired, Braced & Prepped for Ceiling Fan In Living Room & Bedrooms with 2 Switches (Overhead Light Included)
- 2 Pendant Lights over Island or Peninsula Bar (Per Plans)
- LED Recessed Lights: Kitchen, Living Room & Over Shower in Bath #1
- Wall Mounted Vanity Lighting
- Electrical Gage Boxes: Nailed to Stud T/O, Sealed on Exterior Walls
- Exhaust Fans: Vented To Exterior
- General Wiring: Nonmetallic, 12 Gauge General Lighting Minimum
- ARC Fault Breakers Included
- 100 CFM Exhaust Fan @ Bath 1
- Interior Receptacle w/Night Light @ Hallways Greater Than 6' Long
- Two Exterior Receptacles

APPLIANCES – STAINLESS STEEL

- Dishwasher
- Ventless Designer Canopy Range Hood (2 to Choose From)
- Includes Dryer Vent Box Recessed in Wall
- Dryer Ducted by Purchaser
- All Other Appliances: OPTIONAL

CONSTRUCTION ZONE DESIGN

- 20# Roof Load
- 90 MPH Construction/115 Vult
- Engineering/Submittal Fees (Up to \$715)
- Stamped Prints for Permitting
- Pro-Set Included
- 2/10 Warranty
- NTA Labels

TABLE OF CONTENTS

A DESIGN GUIDE FOR YOUR HOME

NATIONWIDE
SERIES

KITCHEN

CABINETS & PULLS • BACKSPLASH • COUNTERTOPS • RANGE HOODS • APPLIANCES & SINKS

BATHROOM & LAUNDRY

SINKS & UTILITY • WALK-IN SHOWERS • BATHTUBS & STALLS • ACCESSORIES

LIGHTING & FIXTURES

LIGHTING • HARDWARE • PLUMBING FIXTURES

FLOORING

CARPET • LUXURY VINYL • LAMINATE

EXTERIORS

VINYL SIDING • ROOFING • SHUTTERS • DECKING • DORMERS • DOORS • WINDOWS

INTERIORS

FIREPLACES • ACCENT WALLS • FARMHOUSE • PANTRY & CLOSET • NICHE • MILLWORK

ADDED VALUE

KITCHEN • BATHROOM • LAUNDRY & UTILITY • GENERAL CONSTRUCTION AND MORE

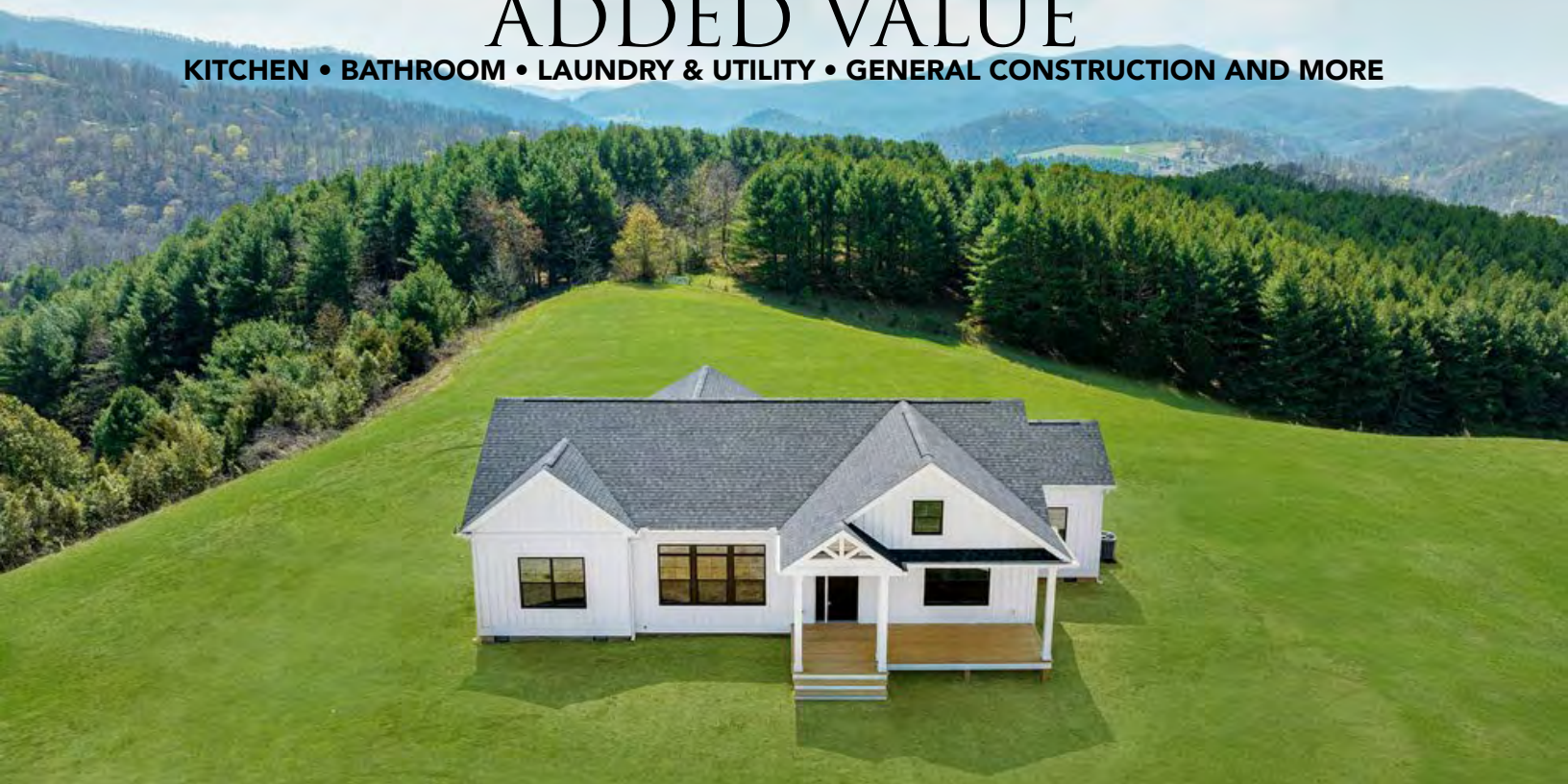

SPRING/SUMMER 2025

KITCHEN

Southampton Floor Plan



NATIONWIDE
SERIES

STANDARD FINISHES

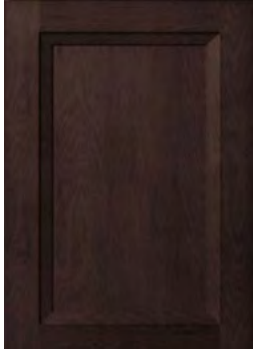

ASH WALNUT

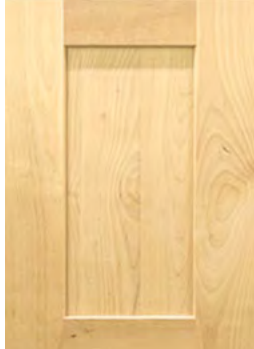

NATURAL



TRUE WHITE

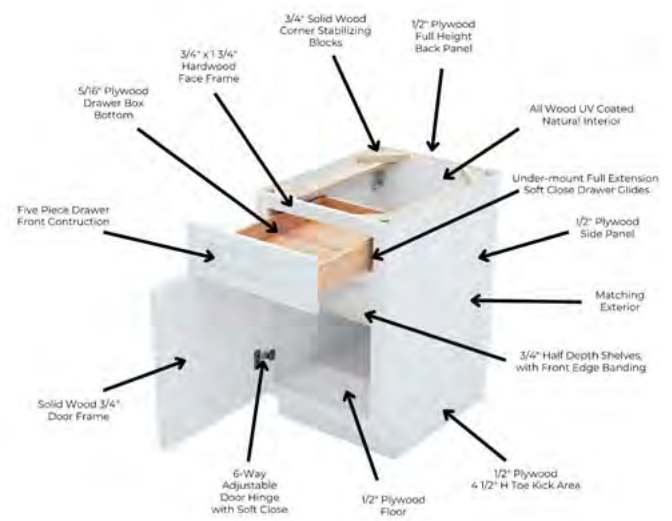

OPTIONAL FINISHES

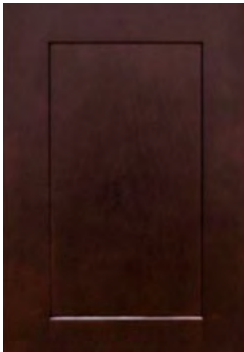

ESPRESSO



DOVE GREY

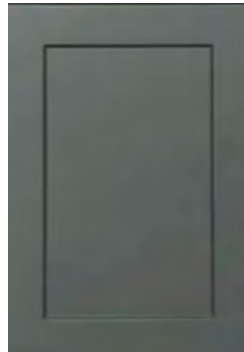

SLATE GREY



SAGE GREEN



NEW BLUE



BLACK

AVAILABLE FOR KITCHEN ISLANDS ONLY

PULLS & KNOBS



GOLD PULL
OPTIONAL



GOLD KNOB
OPTIONAL



BLACK PULL
OPTIONAL



BLACK KNOB
OPTIONAL



NICKEL PULL
OPTIONAL



NICKEL KNOB
OPTIONAL

WHICH CABINETS HAVE YOU SELECTED?

Kitchen Base: _____

Bath One: _____

Kitchen Wall: _____

Bath Two: _____

Island: _____

Bath Three: _____

Laundry: _____

Other: _____



NONE
Omit

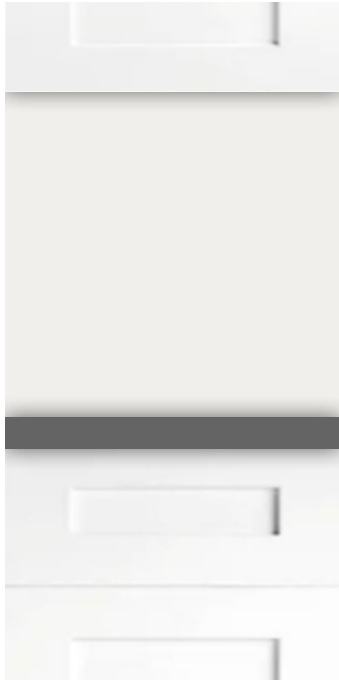

STANDARD
4-6" Total Height

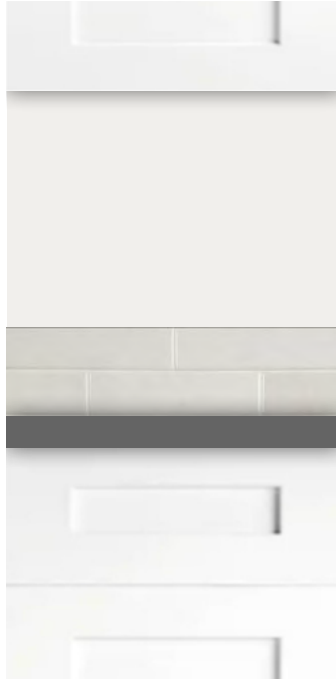

OPTIONAL
Full Height



STANDARD HEIGHT TILE (4 - 6" Total Height)



MATCHING LAMINATE 4"



DENIM 6" Stack



DOVE 6" Stack



CALCUTTA 4" Row



JADE 6" Stack

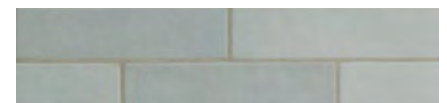

SKY 6" Stack



FOSSIL 4" Row



STERLING 6" Stack



STORM 3x12" Stack



SUGAR CANE
Grout-less 4" Row

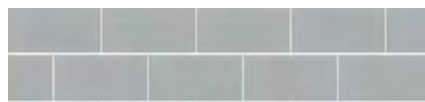

DESERT GREY 6" Stack

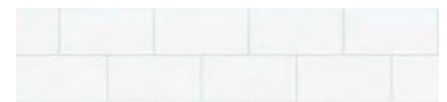

ARCTIC WHITE 6" Stack



BLANC 6" Row



GRIS 6" Row

OPTIONAL FULL HEIGHT TILE

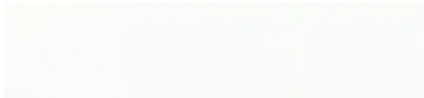

[] **BLANC** 6x18" Tile



[] **GRIS** 6x18" Tile



[] **CALCUTTA** 4x12" Tile

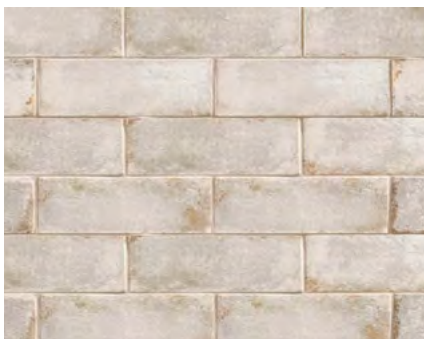

[] **FOSSIL** 4x9" Tile



[] **SUGAR CANE**
Grout-less 4x8" Tile



[] **DENIM** 3x12" Tile



[] **JADE** 3x12" Tile



[] **STERLING** 3x12" Tile



[] **DESERT GREY**
Subway 3x6" Tile



[] **DOVE** 3x12" Tile

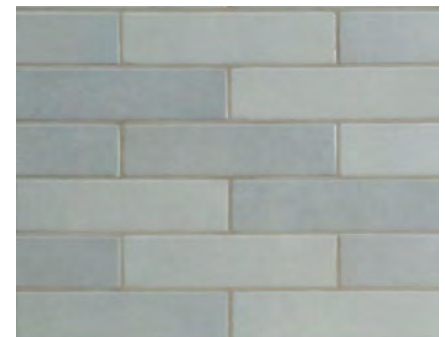

[] **SKY** 3x12" Tile

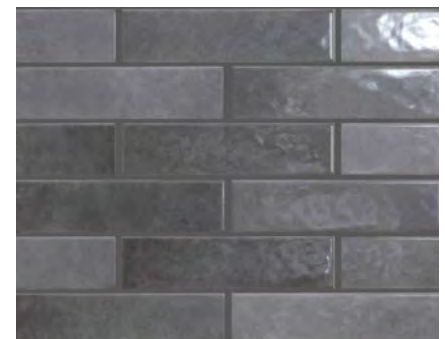

[] **STORM** 3x12" Tile



[] **ARCTIC WHITE**
Subway 3x6" Tile

STANDARD LAMINATE COUNTERTOP

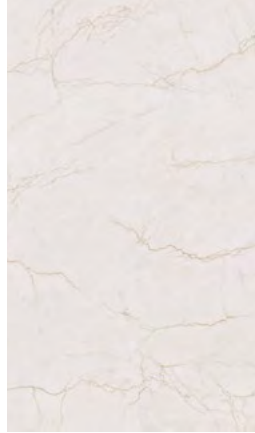

[]
ALUMA MARBLE



[]
BELLO ROMANO

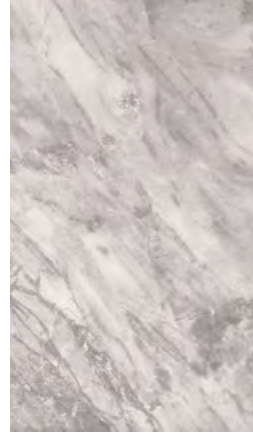

[]
BRAZILIAN BLUE



[]
CRYSTAL QUARTZITE

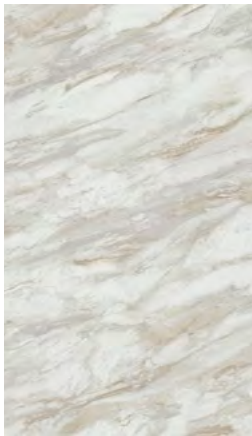

[]
DRAMA MARBLE

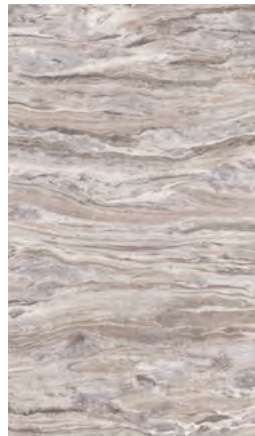

[]
GLACIER QUARTZITE

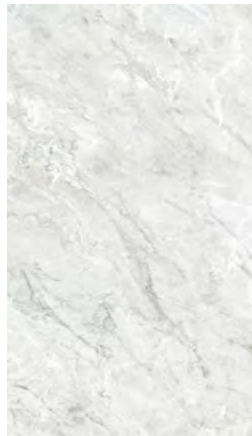

[]
ICE MIST



[]
LAKESHORE



[]
MARMO BIANCO



[]
PORTORO

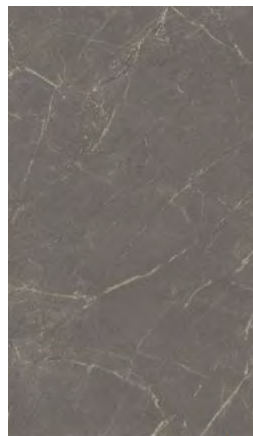

[]
TERRENA SOAPSTONE



**LAMINATE CRESCENT EDGE
STANDARD**



OPTIONAL QUARTZ



[] AXBRIDGE [] CALACATTA LAZA [] CARRARA MIKSA [] CARRARA MIST [] FOSSIL GRAY



[] SPARKLING WHITE [] TRAFALGAR [] WARWICK [] WILLOW WHITE

OPTIONAL GRANITE



[] BLACK PEARL [] DALLAS WHITE [] LUNA PEARL

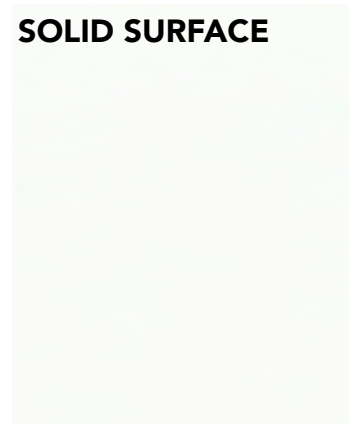

[] ARCTIC WHITE
by LG Hi-MACS (Baths Only)

RANGE HOODS

STAINLESS, GLASS, OR WOOD



[] **30" STAINLESS**
CANOPY HOOD - STANDARD



[] **36" GLASS & STAINLESS**
CANOPY HOOD - STANDARD



[] **36" GLASS & BLACK**
CANOPY HOOD - OPTIONAL



[] **36" BEAM & SHIPLAP**
NATIONWIDE DURABUILT HOOD - OPTIONAL
*Black Range Hood with Brown Stain Contrast Shown**

RANGE HOOD COLOR:

Available in all cabinet colors*

BOTTOM TRIM COLOR:

Available in all cabinet and ceiling beam colors*

*36" BEAM & SHIPLAP RANGE HOOD IN NEW BLUE WITH MATCHING TRIM SHOWN**

APPLIANCES & SINKS

WHIRLPOOL APPLIANCE PACKAGE

NATIONWIDE
SERIES



APPLIANCES (Available in Black or Stainless Steel)



**OVER-THE-RANGE
MICROWAVE**
[] BLACK
[] STAINLESS STEEL



[] **ELECTRIC RANGE**

[] BLACK
[] STAINLESS STEEL



[] **GAS RANGE**

[] BLACK
[] STAINLESS STEEL



[] **SIDE-BY-SIDE**

[] BLACK
[] STAINLESS STEEL



[] **FRENCH DOOR**

[] BLACK
[] STAINLESS STEEL



DISHWASHER

[] BLACK
[] STAINLESS STEEL

KITCHEN & BAR SINKS



[] **DROP-IN STANDARD
TOPMOUNT 50/50**
LAMINATE STANDARD



[] **FIRECLAY FARMHOUSE
UNDERMOUNT 50/50**
GRANITE/QUARTZ OPTION



[] **FIRECLAY FARMHOUSE
UNDERMOUNT SINGLE**
GRANITE/QUARTZ OPTION



[] **URBAN SERIES LOW RADIUS
UNDERMOUNT 50/50**
GRANITE/QUARTZ OPTION



[] **URBAN SERIES LOW RADIUS
UNDERMOUNT BAR SINK**
GRANITE/QUARTZ OPTION



[] **URBAN SERIES LOW RADIUS
UNDERMOUNT BAR XL/UTILITY SINK**
GRANITE/QUARTZ OPTION



[] **33x22" STAINLESS STEEL
SINGLE BOWL FARMHOUSE SINK**



[] **33x22" PVD GUNMETAL 50/50
DOUBLE BOWL FARMHOUSE SINK**



[] **TOPMOUNT**
LAMINATE COUNTERTOPS



[] **UNDERMOUNT**
GRANITE/QUARTZ COUNTERTOPS

PICTURES ARE FOR REPRESENTATION ONLY – REFER TO SAMPLES FOR ACTUAL COLORS

SPRING/SUMMER 2025

BATHROOM & LAUNDRY



Sparta Cape Alternate Floor Plan
NATIONWIDE
SERIES

BATHROOM SINKS



[] **DROP-IN VITREOUS CHINA**
STANDARD
FOR LAMINATE COUNTERTOPS



[] **UNDERMOUNT PORCELAIN**
OPTIONAL
FOR GRANITE & QUARTZ



[] **INTEGRATED SOLID SURFACE**
OPTIONAL
ONLY AVAILABLE IN ARCTIC WHITE

UTILITY ROOM FEATURES



[] **OPTIONAL PET SHOWER**
WITH HAND WAND



STANDARD CUBBY
SHOWN ON STANDARD FLOOR PLAN



ABOVE WASHER/DRYER STORAGE
STANDARD (When Applicable)*



[] **OPTIONAL DEEP DROP-IN**
ACRYLIC UTILITY SINK

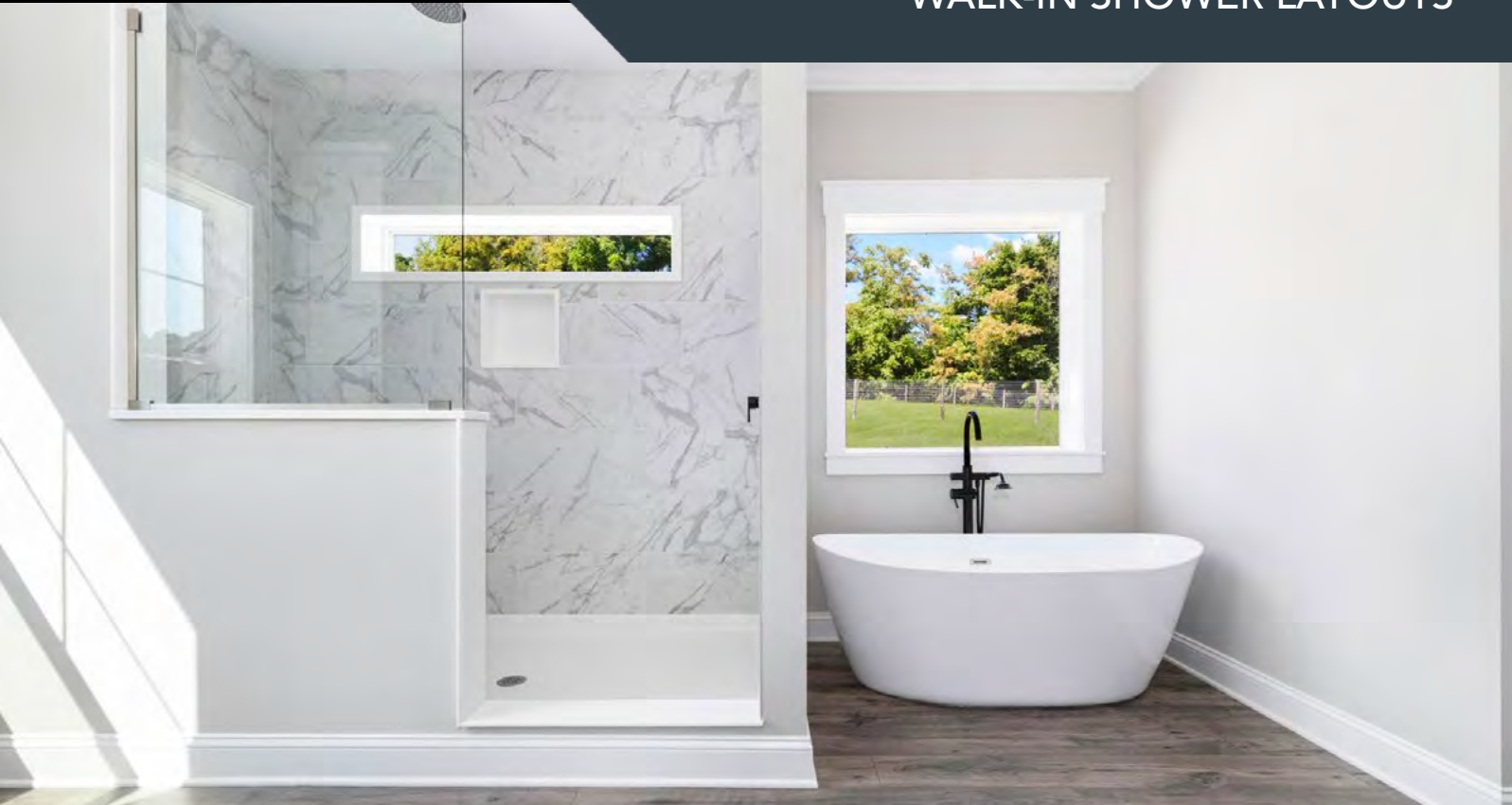

OPTIONAL 4x8' LUXURY SHOWER WITH BENCH (CALCUTTA EMPIRE TILE) + OPTIONAL FREE-STANDING TUB SHOWN

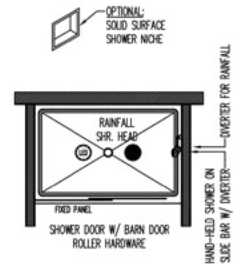
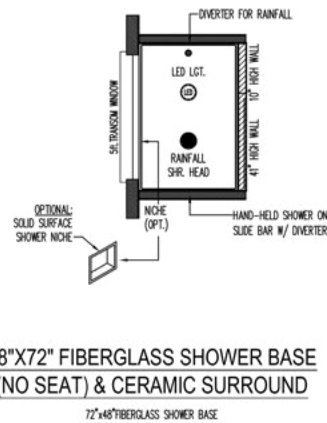
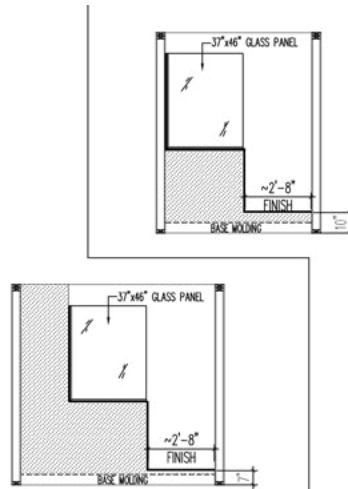
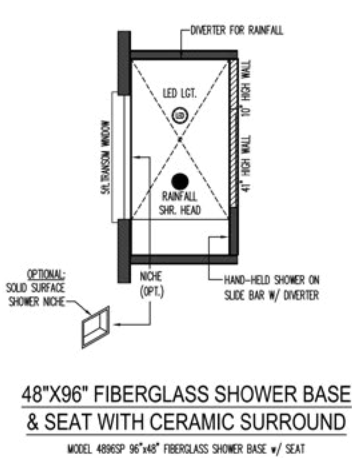

48"X72" FIBERGLASS SHOWER BASE (NO SEAT) w/ CERAMIC SURROUND
72"x48" FIBERGLASS SHOWER BASE (NO WALL ALONG ENTRANCE)

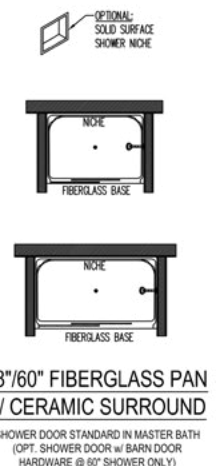
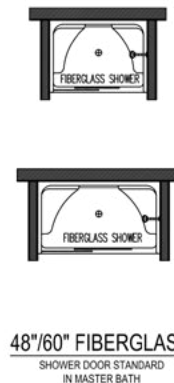
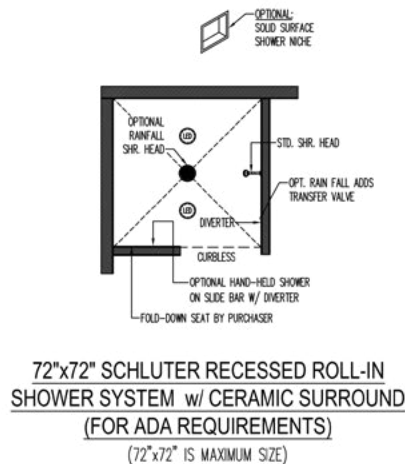
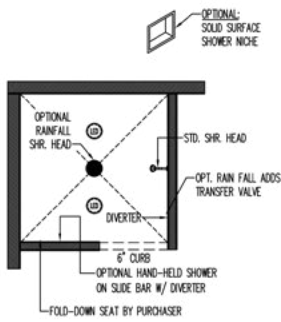

WALK-IN SHOWERS

CERAMIC TILE

NATIONWIDE
SERIES

STANDARD



[] **CALCUTTA EMPIRE** 12x24" Tile



[] **OXIDE IRON** 12x24" Tile

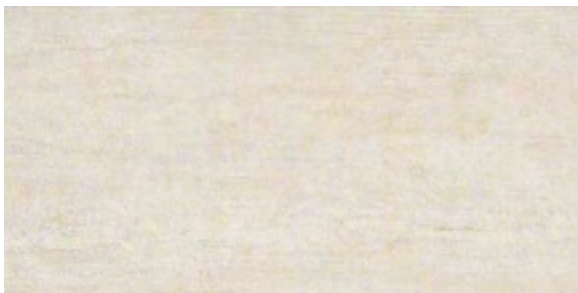

[] **METROPOLIS AVIORO** 12x24" Tile



[] **OXIDE MAGNETITE** 12x24" Tile

OPTIONAL

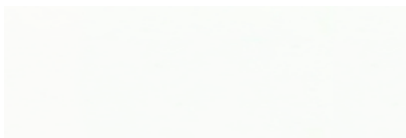

[] **BLANC** 6x18" Tile

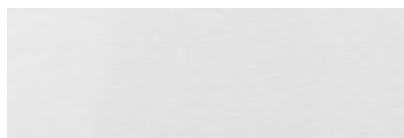

[] **GRIS** 6x18" Tile

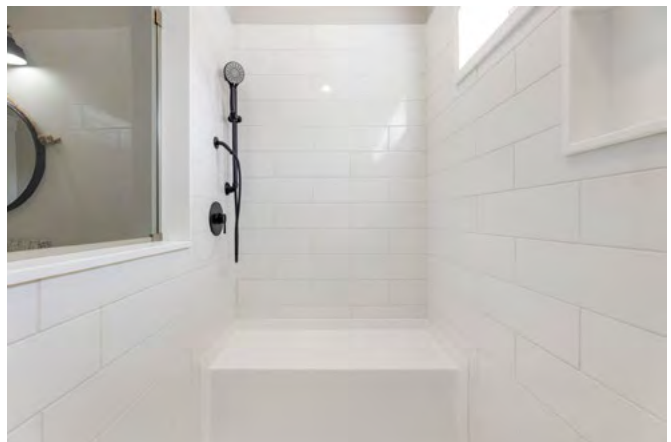
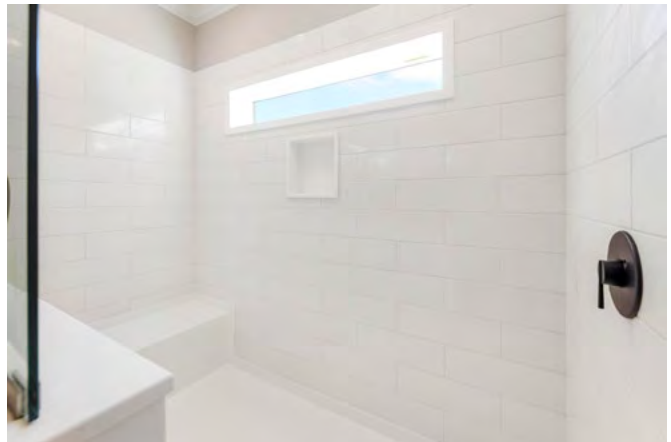

OPTIONAL 4x8' LUXURY SHOWER WITH BENCH
SHOWN WITH OPTIONAL BLANC TILE

SHOWER & BATHTUB STALLS



STANDARD TUB/SHOWER COMBINATION



OPTIONAL 60" SHOWER WITH INTEGRATED BENCH

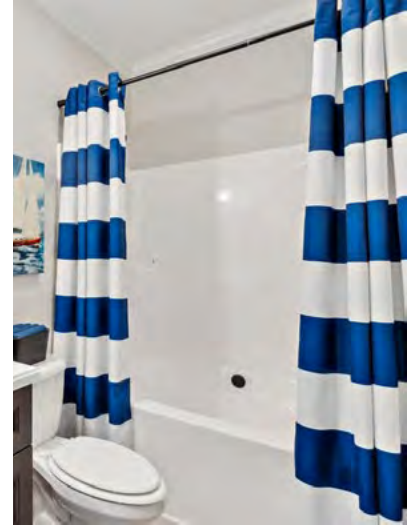

OPTIONAL GARDEN TUB/SHOWER COMBINATION

FREE-STANDING BATHTUBS



OPTIONAL FREE-STANDING BATHTUB
WHITE



OPTIONAL FREE-STANDING BATHTUB
BLACK

ACCESSORIES

BENCHES, MIRRORS, AND MORE.

NATIONWIDE
SERIES

STANDARD ACCESSORIES



SOLID PINE WOOD FRAME MIRROR

CHARCOAL WHITE
 BROWN STAIN NATURAL STAIN

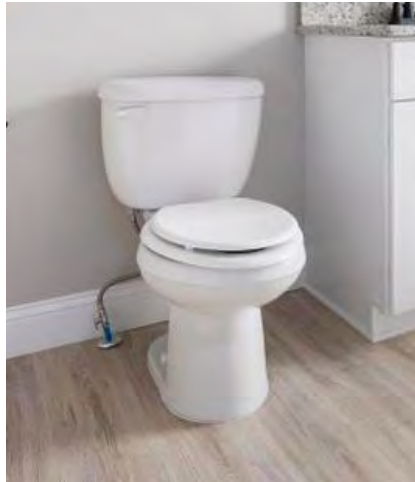

ELONGATED TOILET

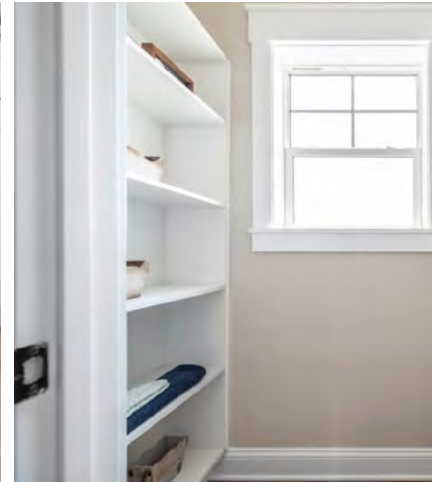

BATHROOM LINEN CLOSET

INCLUDED IF SHOWN ON
STANDARD FLOOR PLAN

OPTIONAL ACCESSORIES



SHOWER BARN DOOR

BLACK NICKEL



ADA BATHROOM VANITY

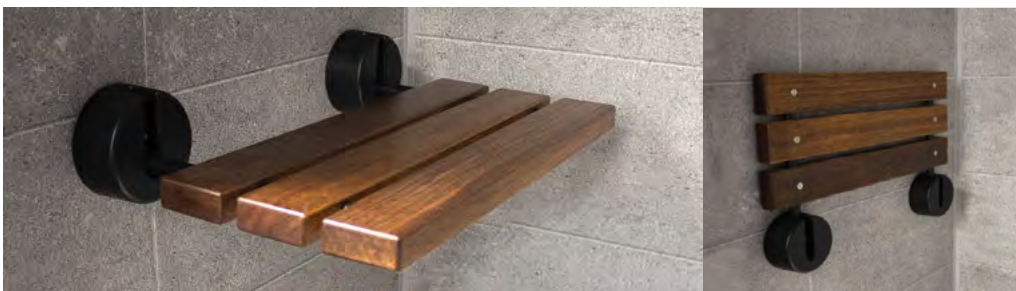

OPTIONAL FOLDABLE TEAK WOOD SHOWER SEAT

DIMENSIONS: 4" H x 20" W x 13.5" D WEIGHT LIMIT: 300 Pounds

PICTURES ARE FOR REPRESENTATION ONLY – REFER TO SAMPLES FOR ACTUAL COLORS

SPRING/SUMMER 2025

LIGHTING & FIXTURES



Sparta Cape Alternate Floor Plan

NATIONWIDE
SERIES



OPTIONAL INDIVIDUAL LIGHTING



[] URBAN FARMHOUSE
CHANDELIER



[] SEDONA CHANDELIER



[] 8" FARMHOUSE WHITE
METAL SCONCE
EXTERIOR OR INTERIOR



[] 12" FARMHOUSE
WHITE METAL PENDANT



[] EXTERIOR
CANDELABRA LANTERN



RECTOR WALL SCONCE
[] GUN METAL [] BLACK



[] EXTERIOR
PEWTER LANTERN

[] **STANDARD BRUSHED NICKEL PACKAGE**



Dining Room Chandelier



Pendant
w/8" Seeded Glass



2-Light Flush
Bedroom



6" Recessed LED



2-Light Bath Vanity
w/Seeded Glass



Interior Door
Lever Set



Square
Cabinet Knob



Bar Pull



STD - Exterior
Black Hex Lantern

[] STANDARD BRUSHED NICKEL PACKAGE



Kitchen Pulldown



Lavatory



Tub/Shower



Shower



Kitchen Spring Faucet



Pedestal Tub Filler
Floor Mount



Hand-Held Shower Kit
Incl. w/4x6 & 4x8 Showers



Garden Tub



Rain Shower Head
Incl. w/4x6 & 4x8 Showers

[] OPTIONAL PFISTER FIXTURES

(Substitution available in any fixture package)

Pfister
FAUCETS



[] NICKEL PULL DOWN FAUCET

[] BLACK PULL DOWN FAUCET



[] NICKEL BATH FAUCET



[] BLACK BATH FAUCET



[] NICKEL BATH FIXTURES



[] BLACK BATH FIXTURES

[] OPTIONAL BLACK PACKAGE



Dining Room
Chandelier



Black Cord Pendant
w/8" Seeded Glass



6" Recessed LED



2-Light Flush LR/BR



2-Light Bath Vanity
w/Seeded Glass



Square
Cabinet Knob



Bar Pull



Door Knob Set
(Black Door Hardware Incl.)



Kitchen
Pulldown



Bath
Lavatory



Bath
Tub/Shower



Bath
Shower



Bath
Pedestal Tub Filler
Floor Mount



Bath
Hand-Held Shower Kit
Incl. w/4x6 & 4x8 Showers

LIGHTING & FIXTURES

OPTIONAL FARMHOUSE PACKAGE

NATIONWIDE
SERIES

[] OPTIONAL FARMHOUSE PACKAGE



Chariot Chandelier



Cage Pendant



6" Recessed LED



2-Light Flush LR/BR



Blast 2-Light
Vanity



Square
Cabinet Knob



Bar Pull



Door Knob Set
(Black Door Hardware Incl.)



Kitchen
Pulldown



Bath
Lavatory



Bath
Tub/Shower



Bath
Shower



Bath
Pedestal Tub Filler
Floor Mount



Bath
Hand-Held Shower Kit
Incl. w/4x6 & 4x8 Showers

NATIONWIDE
SERIES
Tidewater Floor Plan



SPRING/SUMMER 2025

FLOORING



STANDARD "CAPE CANAVERAL" 25oz.

Bedrooms, Bedroom Closets, Den, and Other Secondary Rooms



[]
FOLKLORE



[]
FOSSIL

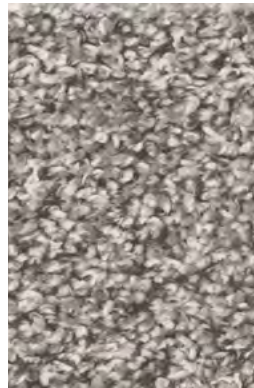

[]
LONDON FOG



[]
MUSHROOM



[]
NATURE TRAIL



[]
NUTRIA



[]
POTTERY



[]
SILVERSMITH



[]
SUNRISE

OPTIONAL "TRUE SPIRIT" 39oz.

Bedrooms, Bedroom Closets, Den, and Other Secondary Rooms



[]
LADY LIBERTY



[]
CONCRETE



[]
CITY SPACE



[]
TRUFFLE



[]
COTTAGE

STANDARD RESOLVE LUXURY VINYL PLANK



[] BEAR

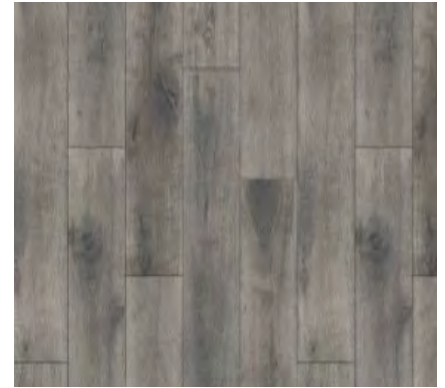

[] ESCAPE II

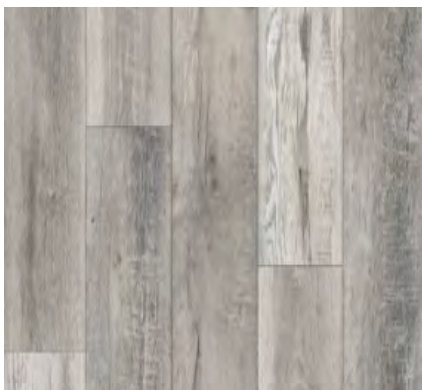

[] FAWN

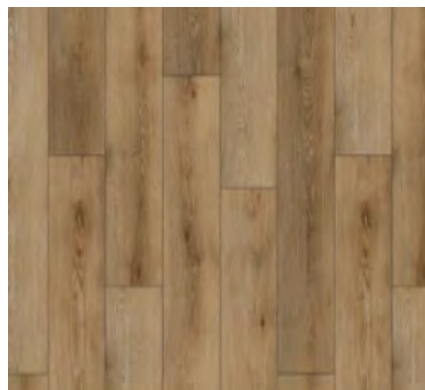

[] VOLT

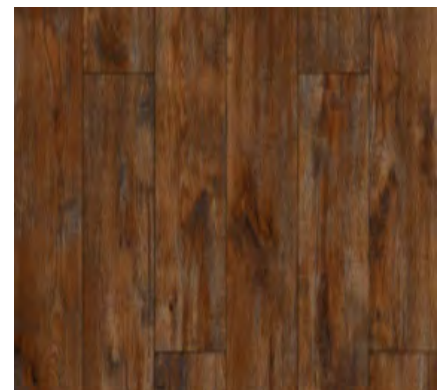

[] WHISKEY BARREL

OPTIONAL MSI CYRUS LUXURY VINYL PLANK

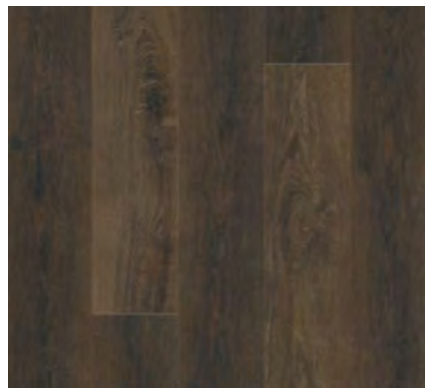

[] BARREL

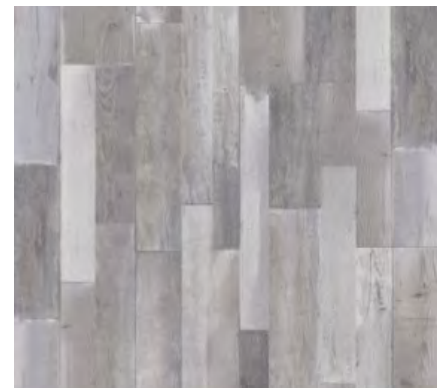

[] WOBURN ABBEY

FLOORING

- [] **STANDARD:** Luxury Vinyl Common Areas + Carpet [] **OPTION II:** Laminate + Carpet
[] **OPTION I:** Luxury Vinyl Entire Home [] **OPTION III:** Laminate Entire House
[] **OTHER:** _____

LAMINATE PLANK

BY MOHAWK INDUSTRIES, INC.

NATIONWIDE
SERIES



OPTIONAL REVWOOD LAMINATE PLANK

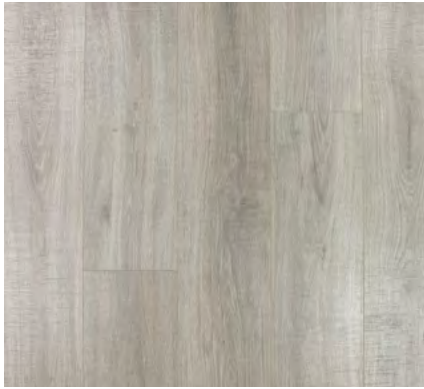

ASHLAR OAK



CEDAR CHESTNUT



DOESKIN CHESTNUT

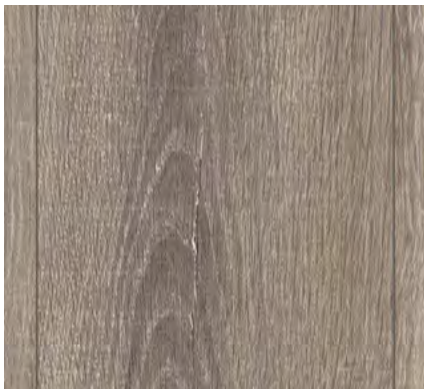

DRIFTWOOD OAK



EASTERN CHESTNUT



FAWN CHESTNUT

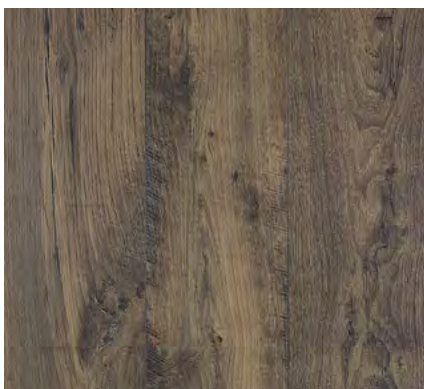

KNOTTED CHESTNUT



SANDCASTLE OAK

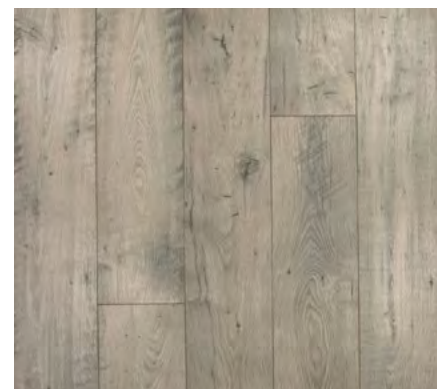

SILVERSTONE CHESTNUT

FLOORING

- STANDARD:** Luxury Vinyl Common Areas + Carpet **OPTION II:** Laminate + Carpet
 OPTION I: Luxury Vinyl Entire Home **OPTION III:** Laminate Entire House
 OTHER: _____

PICTURES ARE FOR REPRESENTATION ONLY – REFER TO SAMPLES FOR ACTUAL COLORS

SPRING/SUMMER 2025

EXTERIOR

YOUR GUIDE TO
*exterior
styling*



Farmhouse I Floor Plan

NATIONWIDE
SERIES

EXTERIOR GALLERY

MODERN FARMHOUSE EXTERIORS ARE AVAILABLE FOR EVERY FLOOR PLAN WE BUILD

NATIONWIDE
SERIES



Garland



Farmhouse II



Chatham I



Sparta Cape Alternate



Southampton



Whitfield



STANDARD MARKET SQUARE SMART STYLES

Double 5" Straight Lap

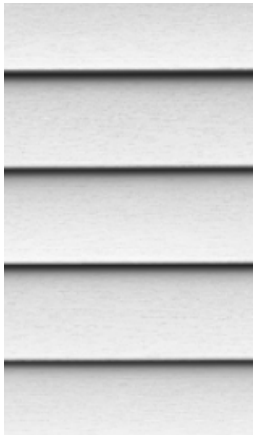

[]
ASPEN WHITE

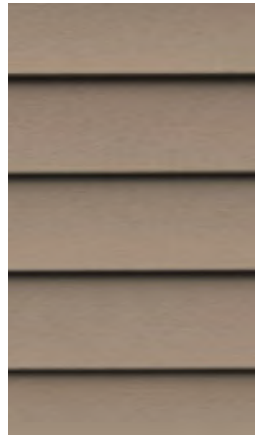

[]
CLAY

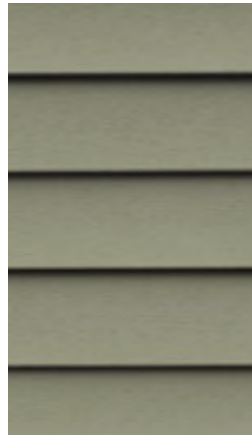

[]
CYPRESS

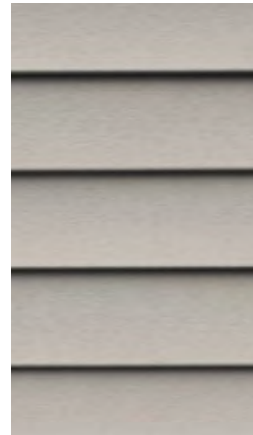

[]
DRIFTWOOD

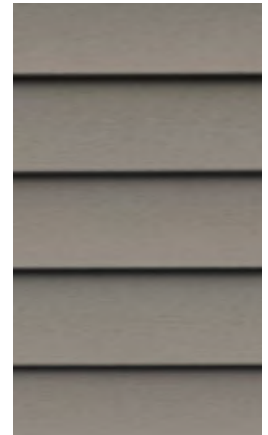

[]
GREYSTONE

OPTIONAL MARKET SQUARE SMART STYLES

Double 4" Straight Lap

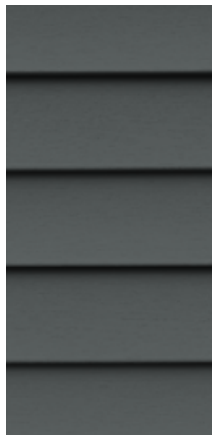

[]
CARBON
EXPRESSIONS

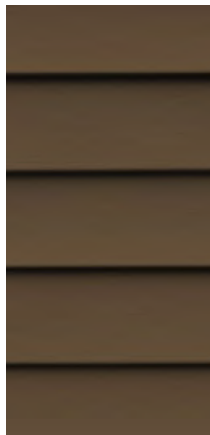

[]
ESPRESSO
EXPRESSIONS

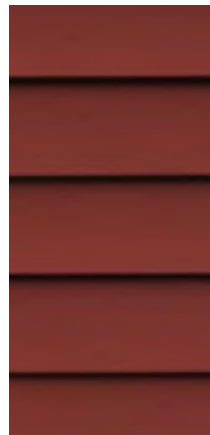

[]
LIGHTHOUSE RED
EXPRESSIONS

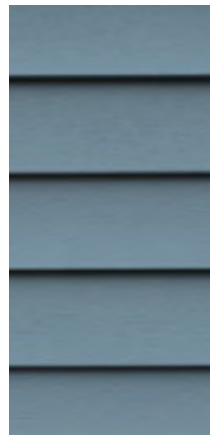

[]
POLARIS
PREMIUM

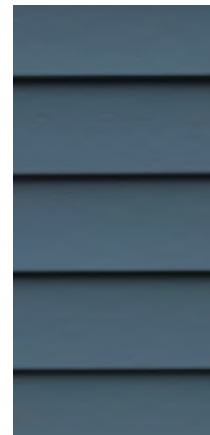

[]
REGATTA
EXPRESSIONS

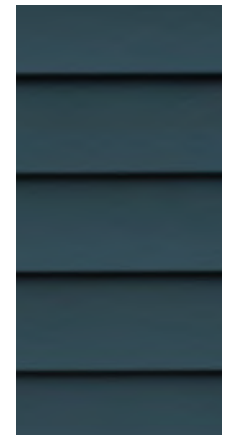

[]
SLATE
EXPRESSIONS



[]
BOARD & BATTEN
7"



[]
BOARD & BATTEN
10" SOLID CORE

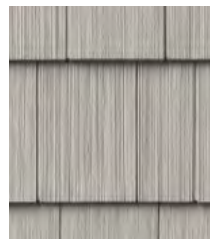

[]
CEDAR SHAKE

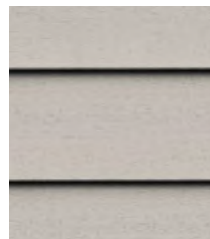

[]
DOUBLE 7" LAP
SOLID CORE



AVAILABLE
IN ALL
COLORS
ABOVE



STANDARD ARCHITECTURAL SHINGLES



GEORGETOWN GRAY MOIRE BLACK SILVER BIRCH WEATHERED WOOD

OPTIONAL SHUTTERS

15" Vinyl Raised Panel



BLACK BLUE GREEN RED

12" Vinyl Open B&B



BLACK BLUE GREEN RED

15" Wood B&B



WOOD
 STAINED (SHOWN)
 UNFINISHED

FACTORY BUILT PORCHES

5/4" x 6" LUMBER (Not Shown)
STANDARD TREATED WOOD DECKING



WHITE VINYL RAILING
White Vinyl Railing and Pickets with
Wrapped 6" x 6" Posts.



BLACK VINYL RAILING
Black Vinyl Railing and Pickets with
Wrapped 6" x 6" Posts.

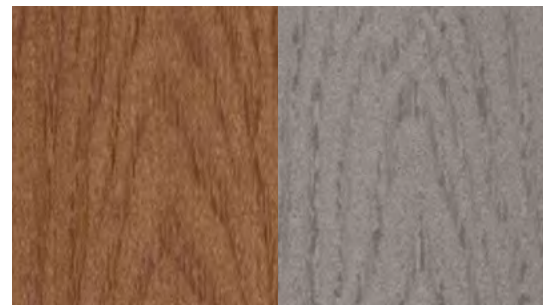

SADDLE PEBBLE GRAY
OPTIONAL COMPOSITE DECKING

DORMERS

OPTIONAL CAPE DORMERS

NATIONWIDE
SERIES

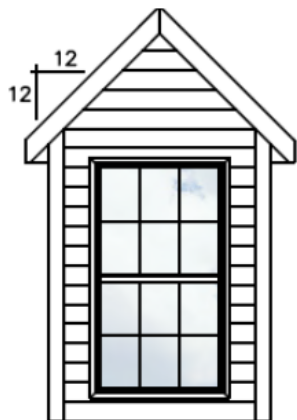

4' Gable

Available on 9/12 or 12/12

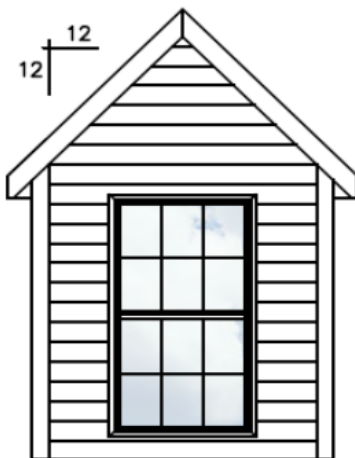

6' Gable

Available on 12/12

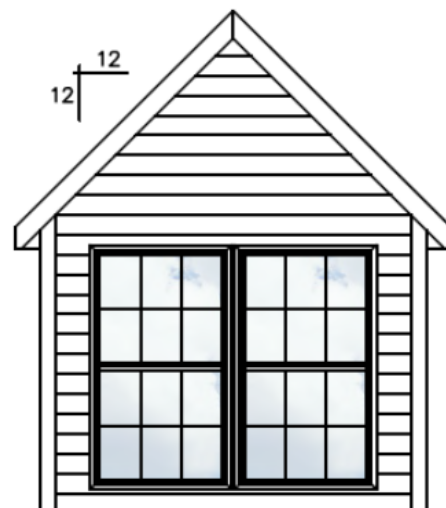

8' Gable

Available on 12/12



4' Shed

Available on 12/12

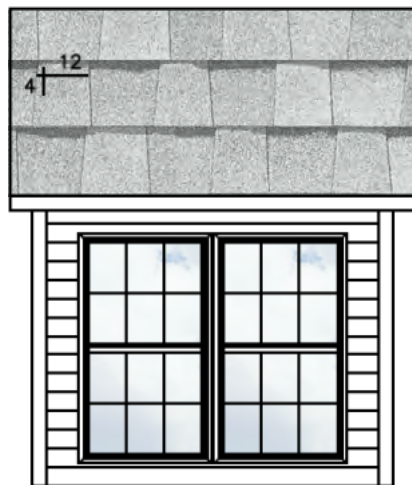

8' Shed

Available on 12/12

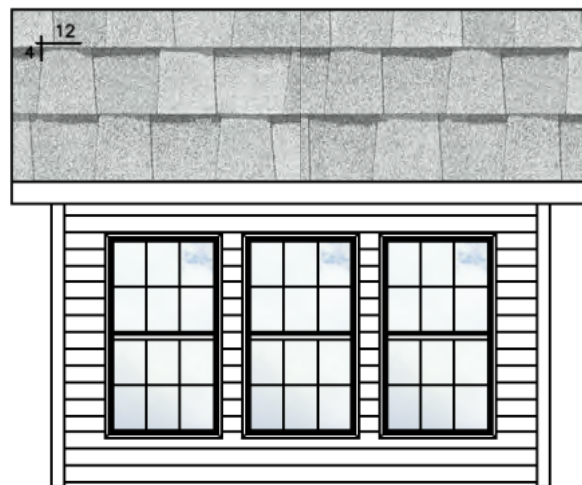

12' Shed

Available on 12/12

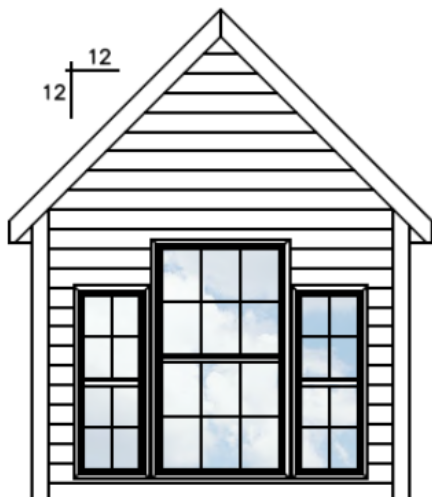

8' Palladian Gable

Available on 12/12

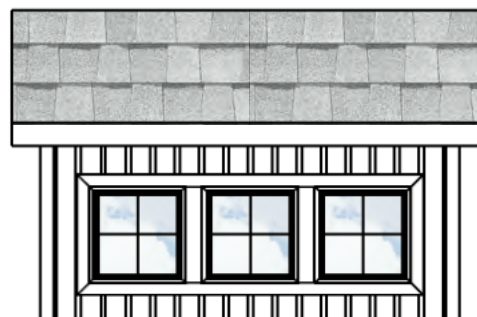

10' Short Shed

Available on 12/12



STANDARD FRONT DOORS

Smooth Fiberglass Entry Doors – Primed (Including Paintable Grids)

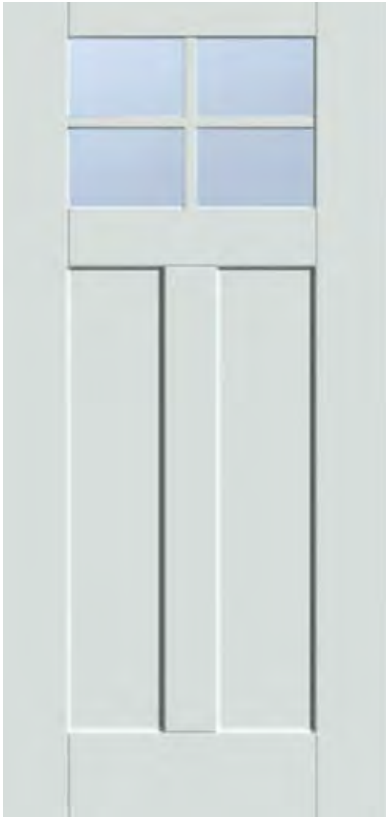

[] CRAFTSMAN
4-Lite S4814



[] 1/2 GLASS
4-Lite S262



[] 3/4 GLASS
4-Lite S2106

STANDARD REAR DOOR & HOME LOCK-SET



PICK RESISTANT



BUMP PROOF



RE-KEY
TECHNOLOGY



SMARTKEY
SECURITY

Kwikset

EXTERIOR DOORS

OPTIONAL BY THERMATRU

NATIONWIDE
SERIES

THERMA TRU[®]
DOORS

OPTIONAL ENTRY DOORS

Primed Smooth Fiberglass (Including Paintable Grids)



[] **2-Panel**
20-Min S220



[] **1/2 GLASS**
No Grids S206



[] **3/4 GLASS**
No Grids S80



[] **FULL GLASS**
No Grids S118



[] **FULL GLASS**
4-Lite S1209

OPTIONAL SMOOTH FIBERGLASS SIDELIGHTS

Primed (Including Paintable Grids)

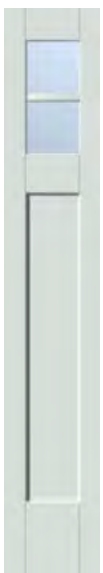

[] **CRAFTSMAN**
S4812 SL



[] **1/2 GLASS**
No Grids
S751 SL



[] **3/4 GLASS**
No Grids
S751 SL



[] **3/4 GLASS**
2-Lite
S2106



[] **FULL GLASS**
No Grids
S751 SL



[] **FULL GLASS**
2-Lite
S1209 SL

SWINGING PATIO DOORS

Primed Smooth Fiberglass (Including Paintable Grids)



3/4 GLASS PATIO
No Grids S80



3/4 GLASS PATIO
4-Lite S2106



FULL GLASS PATIO
No Grids S118



FULL GLASS PATIO
4-Lite S1209

SLIDING PATIO DOORS

Vinyl



WHITE SLIDER
No Grids 214



**WEST WINDOW
GRID SLIDER**
215

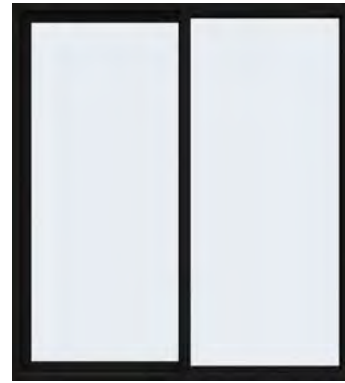

**KINRO
BLACK SLIDER**
No Grids 214

EXTERIOR DOOR TRANSOMS

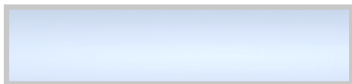

**3/0 1-LITE
TRANSOM**

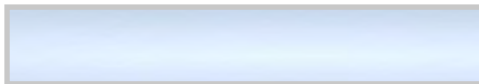

**3/0 x 1/0 1-LITE
TRANSOM**



**1/0 x 3/0 x 1/0 1-LITE
TRANSOM**



PATIO DOOR TRANSOM
Not Available in Black*

WINDOWS

BY KINRO & WEST WINDOW

NATIONWIDE
SERIES

STANDARD WINDOW

White Vinyl: Single Hung with Low-E Glass



[] 4/1 GRID



[] 4/1 GRID

BLACK OPTION:



[] 4/1 GRID
OPTIONAL



[] 4/1 GRID
OPTIONAL

OPTIONAL WINDOW

White Vinyl: Single Hung with Low-E Glass
(Double Hung and Alternate Grid Patterns Optional)



[] 6/6
GRID

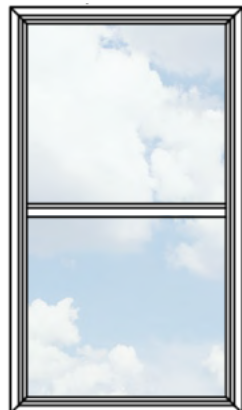

[] 1/1
GRID



[] PRAIRIE
GRID



[] HALF PRAIRIE
GRID



[] 3/1
GRID

SPRING/SUMMER 2025

INTERIOR

Engineered & Custom-built by Nationwide



Whitfield Floor Plan

NATIONWIDE
— MILLWORK —

FIREPLACES

NATIONWIDE DESIGNED & BUILT NICHES

NATIONWIDE
— MILLWORK —

TRADITIONAL & MODERN OPTIONS



42" MONESSEN INSERT:

- LIQUID PROPANE
- NATURAL GAS

STONE SURROUND:

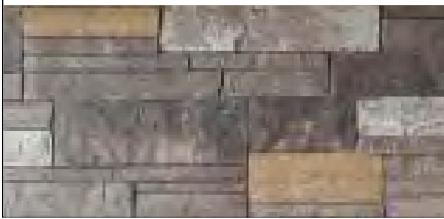

60" MODERN INSERTS:

FULLY RECESSED INTO THE WALL

- MODERN ALLUSION FIREPLACE**
ELECTRIC INSERT WITH 4 FLAME COLORS
DECORATIVE FIRE CRYSTAL IN BASE

SHIPLAP SURROUND

- CHARCOAL WHITE

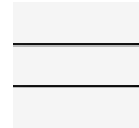

- MODERN MARVEL FIREPLACE**
GAS INSERT WITH STANDARD FLAME
NO DECORATIVE FIRE CRYSTAL
- DRYWALL SURROUND**



VERSETTA STONE & DRYWALL
(WHITE WOOD BORDER SHOWN)

VERSETTA STONE & SHIPLAP
(WHITE WOOD BORDER SHOWN)

FULL VERSETTA STONE
(BROWN WOOD BORDER SHOWN)

WOOD STAIN



- CHARCOAL
- BROWN
- NATURAL
- WHITE

SHIPLAP

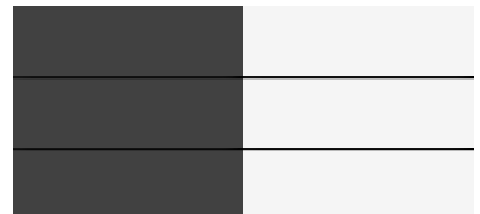

- CHARCOAL
- WHITE

PICTURES ARE FOR REPRESENTATION ONLY – REFER TO SAMPLES FOR ACTUAL COLORS

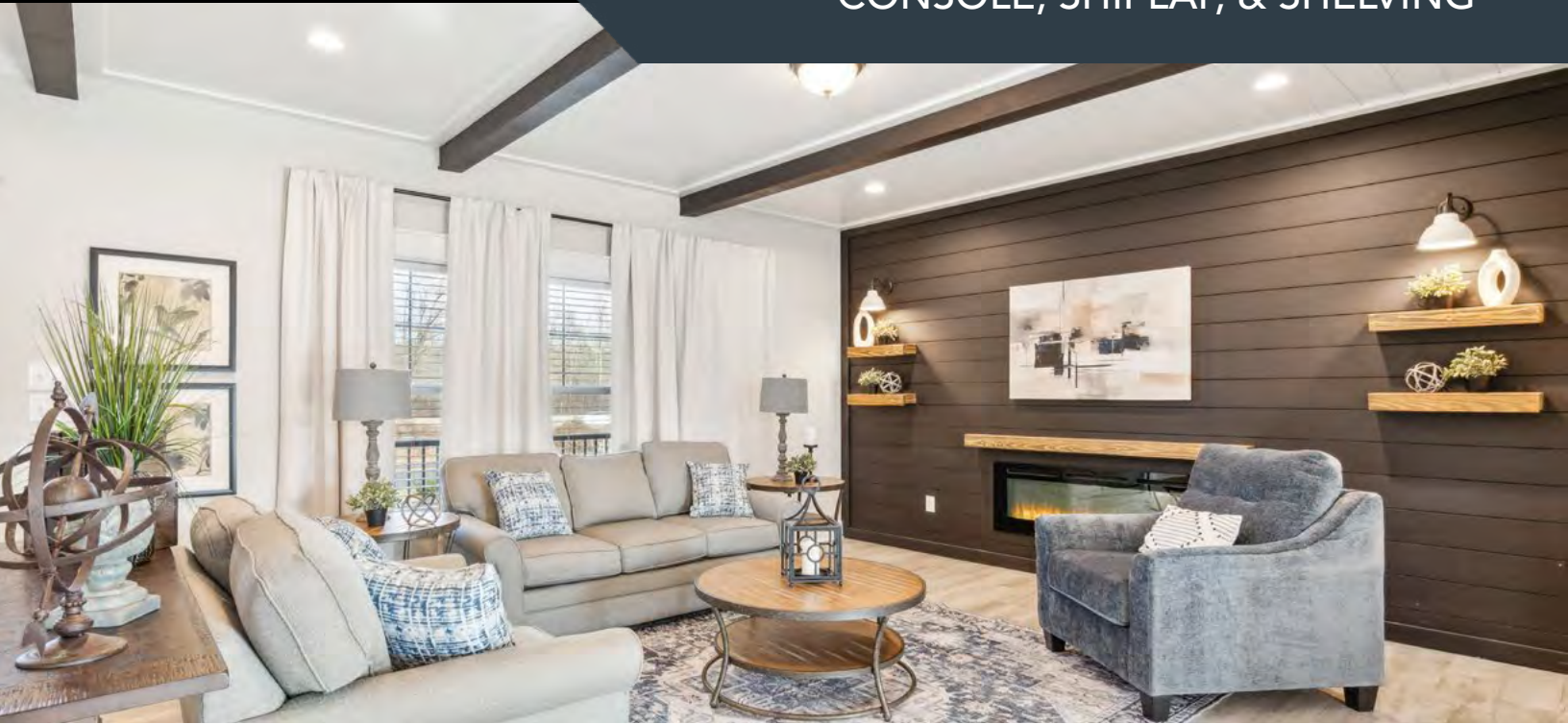

OPTIONAL FEATURE WALLS



SHIPLAP OR SLATS

SHIPLAP: CHARCOAL WHITE NONE WHITE CHARCOAL

SLATS: LIGHT DARK BROWN STAIN NATURAL STAIN

LIGHTING

SCONCE SET: _____

*See lighting section for wall sconce options**

SHELVING

BASE

FIREPLACE & MANTLE

-OR-

CABINET WITH WHITE
SOLID SURFACE COUNTERTOP

FARMHOUSE

OPTIONAL BEAMS, SHIPLAP, & BARN DOORS

NATIONWIDE
— MILLWORK —

CEILING BEAMS & AVAILABLE STAINS



BROWN STAIN & LOCATION: _____



CHARCOAL STAIN & LOCATION: _____



NATURAL STAIN & LOCATION: _____



WHITE PAINT & LOCATION: _____

SHIPLAP (SMOOTH FINISH) & SLAT WALLS (MDF)

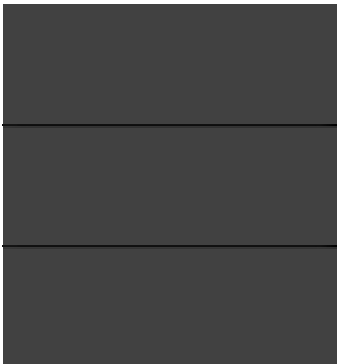

CHARCOAL SHIPLAP

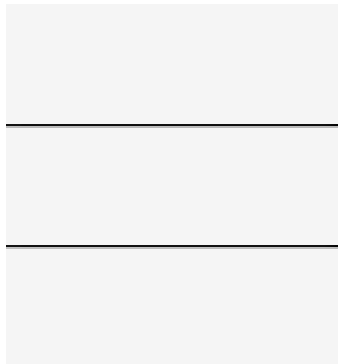

WHITE SHIPLAP



LIGHT SLATS



DARK SLATS

BARN DOORS



WHITE



CHARCOAL



GLASS



BI-FOLD
CHARCOAL



BI-FOLD
WHITE

OPTIONAL KITCHEN & BEDROOM STORAGE

PANTRIES

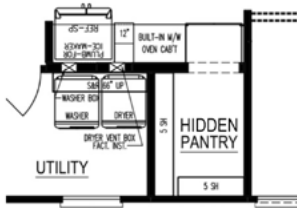

- OPTIONAL HIDDEN PANTRY**
WALK-IN PANTRY HIDDEN BEHIND
FULL-HEIGHT CABINET DOORS
*Check availability in selected model**

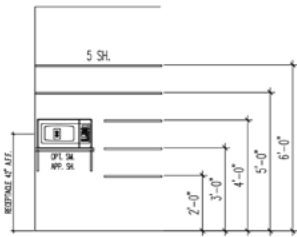

- STANDARD WIRE SHELVING**
- OPTIONAL WOOD SHELVING**
- OPTIONAL APPLIANCE SHELF**



CLOSETS

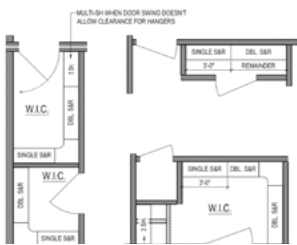

- STANDARD WIRE SHELVING**
- OPTIONAL WOOD SHELVING**
**with continuous slide wood rod*



OPTIONAL RECESSED NICHES

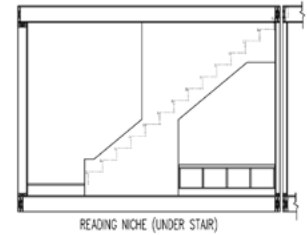

[] **READING NICHE**
BENCH & STORAGE

*ILO closet under stairway**

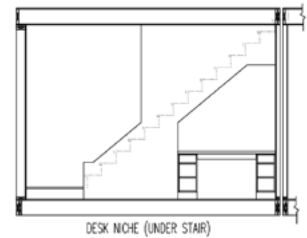

[] **STUDY NICHE**
DESK & STORAGE

*Available under stairway**
*ILO closet under stairway**

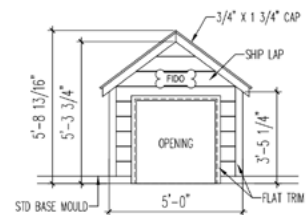

[] **PUPPY NICHE**
SHIPLAP DOGHOUSE

*Available under stairway or recessed in a closet**

INTERIOR DOORS





STANDARD
2-PANEL



OPTIONAL
5-PANEL RIVERSIDE

BARN DOOR OPTIONS:







OPTIONAL CRAFTSMAN TRIM PACKAGE

INCLUDES:
5 ¼" SPEED BASE
4 ¼" CROWN

INTERIOR DOOR HARDWARE



STANDARD
NICKEL LEVER



OPTIONAL
MATTE BLACK KNOB



OPTIONAL
MATTE BLACK LEVER

**INCLUDED WITH OPTIONAL
BLACK AND FARMHOUSE
PACKAGES*

BASEBOARD, CASING, & CROWN



4 ¼" Crown



OPTIONAL
6 ¼" Crown *MDF



3 ¼" Base



OPTIONAL
5 ¼" Speed Base



2 ¼" Casing

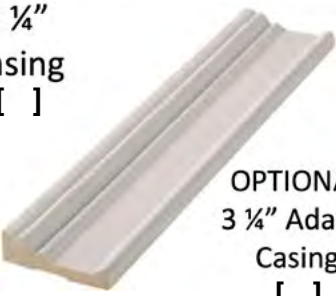

OPTIONAL
3 ¼" Adams Casing

STANDARD
PINE CROWN
PINE BASEBOARD

OPTIONAL (LARGE)
MDF CROWN
PINE BASEBOARD

CLICK IMAGES TO LAUNCH



FARMHOUSE I



FARMHOUSE II



SOUTHAMPTON



SPARTA CAPE ALTERNATE



HEARTLAND I

SPRING/SUMMER 2025

VALUE ADDED

YOUR GO TO FOR
*superior
building*
SINCE 1959



Vertically integrated with factory delivery, factory set-up, and factory service.

NATIONWIDE
SERIES

BUILT-IN VALUE

A NATIONWIDE STANDARD

NATIONWIDE
SERIES

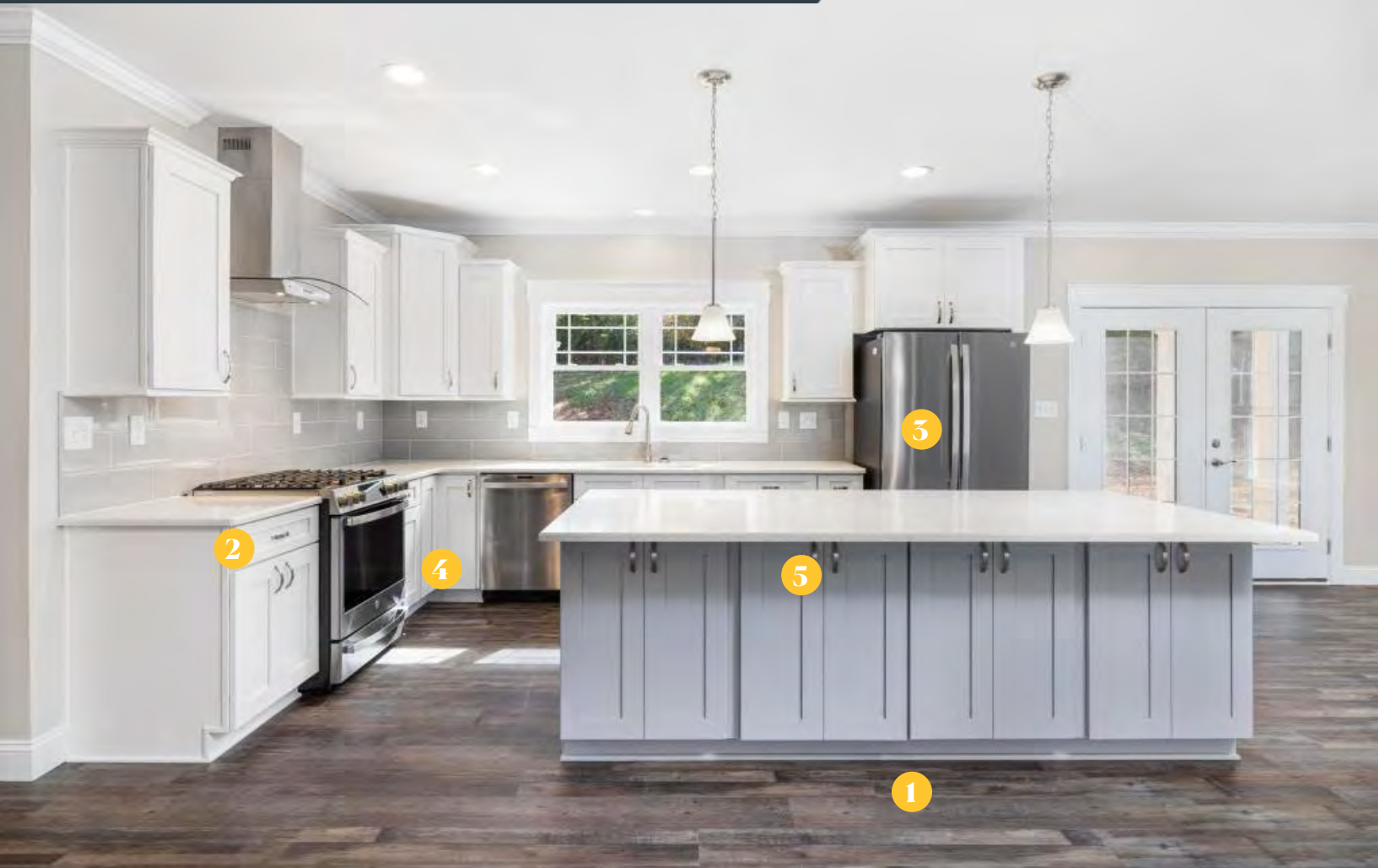

KITCHEN DESIGN



- 1 ADDITIONAL ISLAND SUPPORT**
2x10" FLOOR JOISTS ARE DOUBLED UNDER ISLAND TO PREVENT DEFLECTION



- 2 DOVETAIL CABINET DRAWERS**
WITH UNDER-MOUNT FULL EXTENSION SOFT-CLOSE GLIDES



- 3 RECESSED ICE MAKER BOX**
WITH WATER SHUTOFF



- 4 LAZY SUSAN CORNER CABINET**
NO MORE CLUTTERED CORNERS!
*Standard in kitchens with corner cabinets**



- 5 POTS & PANS 30" OR 36" DRAWER**
ONE DRAWER STACK IN ISLAND OR PENINSULA KITCHENS

PICTURES ARE FOR REPRESENTATION ONLY – REFER TO SAMPLES FOR ACTUAL COLORS

BATHROOM DESIGN



- 1 ADDITIONAL SHOWER SUPPORT**
2x10" FLOOR JOISTS ARE DOUBLED UNDER 4X6' AND 4X8' SHOWERS
- 2 ELONGATED TOILET**
INCREASED COMFORT AND SURFACE FOR SEATING
- 3 NATIONWIDE BUILT MIRRORS**
STANDARD CUSTOM MIRRORS AVAILABLE IN VARIOUS FINISHES
- 4 SMART BATH EXHAUST FAN**
PROGRAMMABLE OR AUTOMATIC VENTILATION (SWITCH IN BATH #1)
- 5 NATIONWIDE BUILT LINEN**
OPEN CONCEPT SHELVING FOR BATH LINENS

STANDARD VALUE ADDED CUSTOM BUILT-INS ARE TO EACH PLAN WHEN SPACE ALLOWS. PLEASE SEE FLOOR PLAN FOR FURTHER DETAILS.

LAUNDRY & UTILITY DESIGN

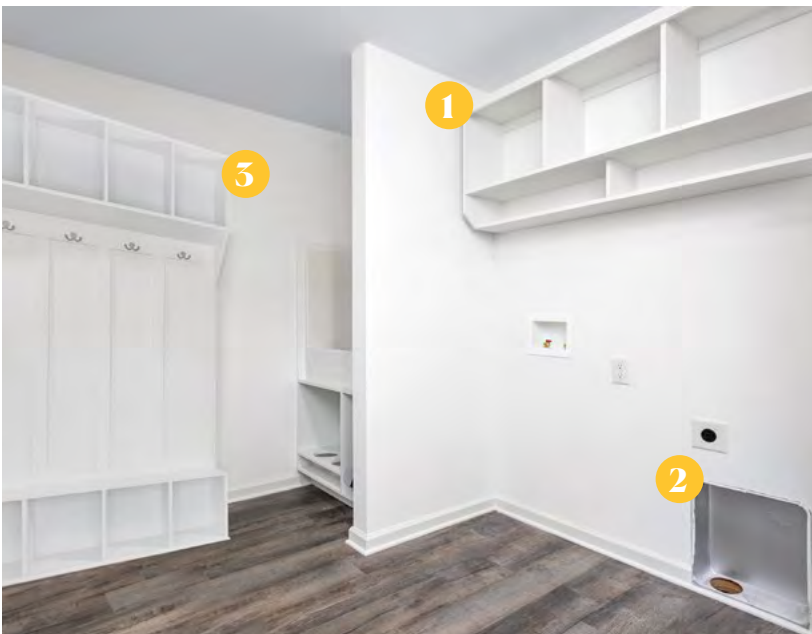

- 1 NATIONWIDE BUILT LAUNDRY**
OPEN CONCEPT SHELVING FOR LAUNDRY ITEMS
- 2 RECESSED DRYER VENT**
PREVENTS CRUSHED DRYER HOSE AND ALLOWS MORE FLOOR SPACE
- 3 NATIONWIDE BUILT CUBBY**
OPEN CONCEPT SHOE STORAGE BENCH AND COAT RACK

STANDARD VALUE ADDED CUSTOM BUILT-INS ARE TO EACH PLAN WHEN SPACE ALLOWS. PLEASE SEE FLOOR PLAN FOR FURTHER DETAILS.

ADDITIONAL VALUE IN YOUR HOME

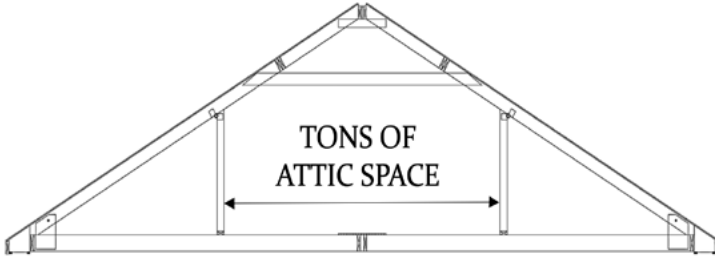

**7/12 ATTIC STORAGE RAFTERS
(NOT SCISSOR TRUSSES)**



**TITAN HOUSE WRAP SYSTEM, ROOF
UNDERLAYMENT, FLASHING, & SEAM TAPE**



**INTERIOR WALL COLOR:
AGREEABLE GRAY (SW7029)**



**LED NIGHTLIGHT RECEPTACLE COVERS FOR
HALLWAYS 6FT OR GREATER**



**PVC TRIM BOARDS WITH
BOARD & BATTEN SIDING**



**PRIMARY BEDROOM
CLOSET CUBBY**



**12-GAUGE WIRING WITH
20 AMP BREAKERS**



USB-C RECEPTACLE